

Miniature SOP-4pin type  
of 60V load voltage

# PHOTO DMOS RELAY BY6S

1 From B



E504629

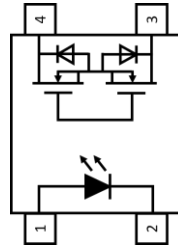
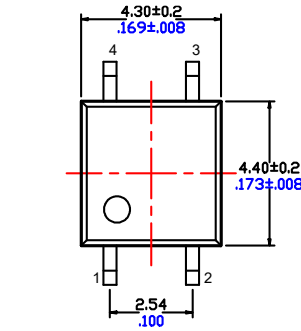
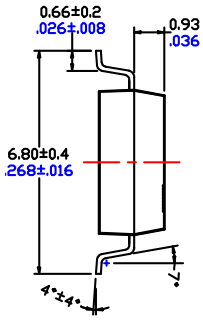

1. LED Anode
2. LED Cathode
3. MOSFET Drain
4. MOSFET Drain

Unit : mm inch  
Tolerance: ±0.1 ±.004

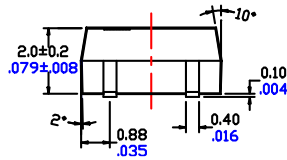

## FEATURE

1. Continuous load current: Max. 500mA.
2. Load on resistance: Typ. 0.8Ω.
3. Loading voltage 60V DC or AC peak.
4. Off-state leakage current: 1μA.

## TYPICAL APPLICATIONS

- Measurement and test equipment
- Telecommunications
- Security equipment
- Industrial machinery and equipment

### Absolute maximum ratings (Ambient temperature 25 °C)

Item		Symbol	Value	Units	Not
Input	Continuous LED current	$I_F$	50	mA	
	Peak LED current	$I_{FP}$	1000	mA	f=100Hz, DC 1%
	LED reverse voltage	$V_R$	5	V	
	Input power dissipation	$P_{in}$	75	mW	
Output	Load voltage	$V_L$	60	V	DC or AC peak
	Load current	$I_L$	500	mA	
	Peak load current	$I_{peak}$	600	mA	1ms(1 pulse)
	Output power dissipation	$P_{out}$	300	mW	
Total power dissipation		$P_T$	350	mW	
I/O isolation voltage		$V_{iso}$	1500	Vrms	RH 60, 1min
Operating temperature		$T_{opr}$	-40o +85	°C	
Storage temperature		$T_{stg}$	-40 to +100	°C	
Soldering temperature		$T_{sol}$	260	°C	10sec max.

### Electrical specifications (Ambient temperature 25 °C)

Item		Symbol	Min.	Typ.	Max.	Units	Condition
Input	LED forward voltage	$V_F$		1.2	1.4	V	$I_F=10mA$
	Operating LED current	$I_{Fon}$		0.5	3.0	mA	
	Recover LED current	$I_{Foff}$	0.1	0.35		mA	
	Recover LED voltage	$V_{Foff}$	0.5			V	
Output	On resistance	$R_{on}$		0.8	1.5	Ω	$I_L=100mA$
	Off-state leakage current	$I_{leak}$			1.0	μA	$I_F=5mA, V_L=Rating$
	Output capacitance	$C_{out}$		165		pF	$I_F=5mA, V_L=0V, f=1MHz$
Transmission	Turn on time	$T_{on}$		0.25	1.0	ms	$I_F=5mA, I_L=100mA$
	Turn off time	$T_{off}$		0.5	2.0	ms	
Coupled	I/O isolation resistance	$R_{I/O}$	$10^9$			Ω	DC 500V
	I/O capacitance	$C_{I/O}$		0.8	1.5	pF	f=1MHz



# RAPIDTEK PHOTO DMOD RELAY

Rapidtek Magnetic Devices Inc.  
<http://www.rapidtek.net>

# PHOTO DMOS RELAY

## 1 Form B Photo Relay

### Reference data

Load current vs. Ambient temperature

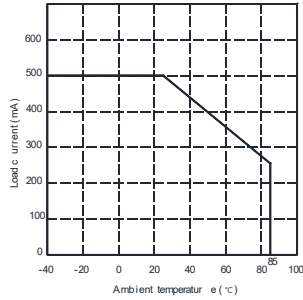

On resistance vs. Ambient temperature

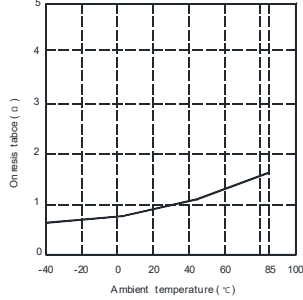

Turn on time vs. Ambient temperature

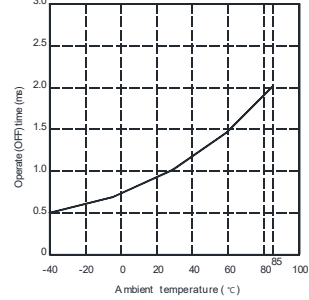

Turn off time vs. Ambient temperature

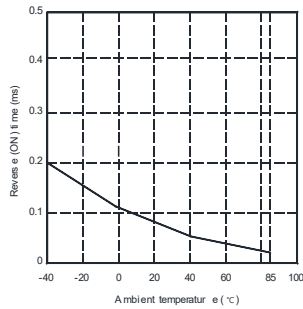

LED operate current vs. Ambient temperature

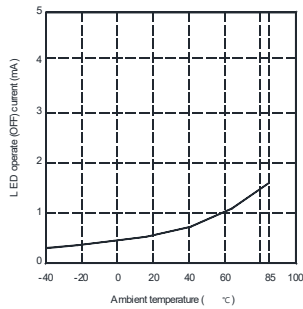

LED turn off current vs. Ambient temperature

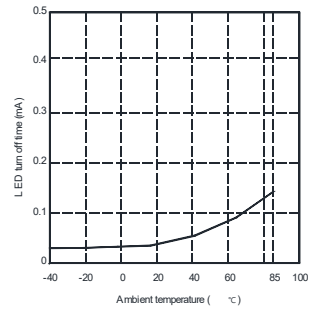

LED forward voltage vs. Ambient temperature

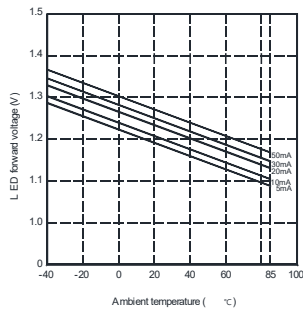

Voltage vs. current characteristics of output at

MOS portion

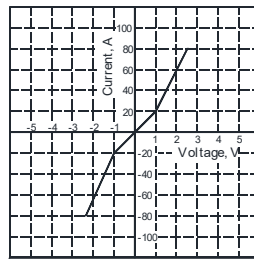

Off state leakage current vs. Load voltage

characteristics

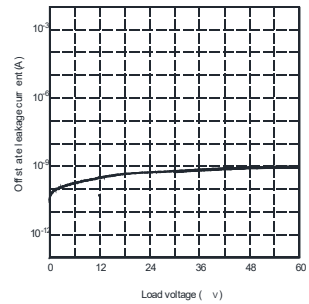

LED forward current vs. Turn on time

characteristics

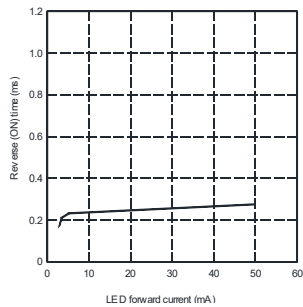

LED forward current vs. Turn off time

characteristics

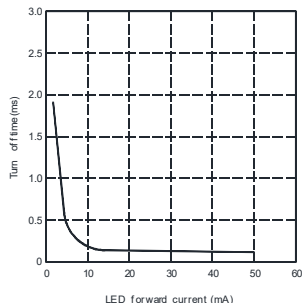

Applied voltage vs. Output capacitance

characteristics

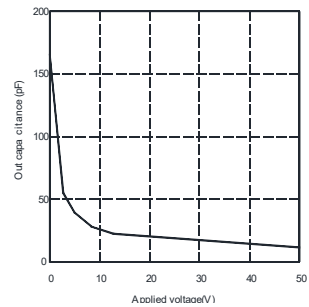

**RAPIDTEK**  
**PHOTO DMOD RELAY**

Rapidtek Magnetic Devices Inc.  
<http://www.rapidtek.net>

# PHOTO DMOS RELAY

## 1 Form B Photo Relay

### Taping specifications for surface mount devices

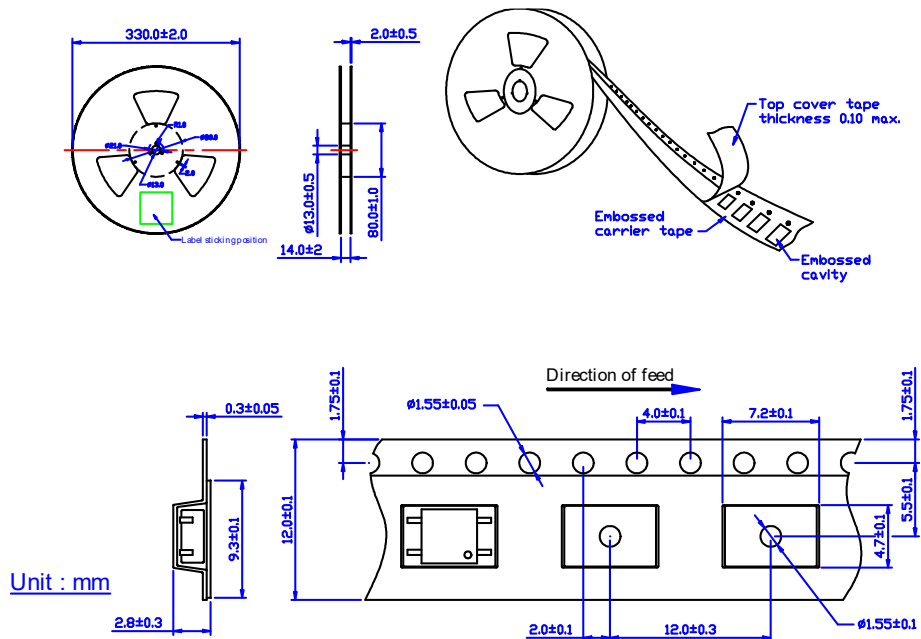

Package	Part No.		Packing quantity	
	Tube packing	Tape & Reel packing	Tube	Tape & Reel
SOP4	BY6S	BY6S-R1	100pcs/1tube	2000 pcs

### Dimension

#### Recommended mounting pad

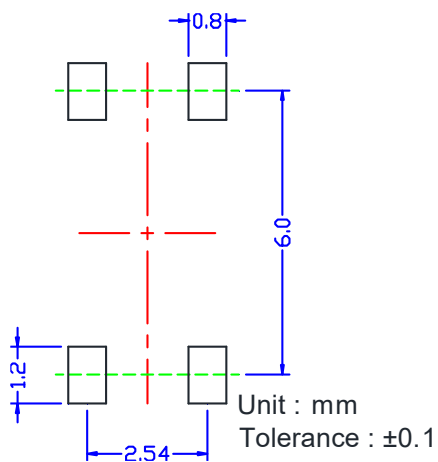

### Marking

(Each photo MOS Relay shall be marked with the following information)

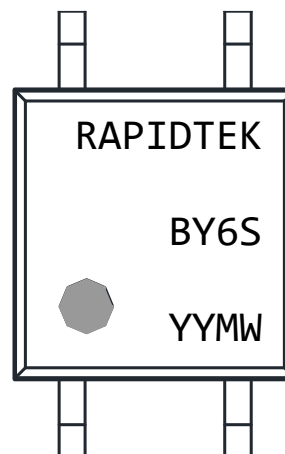

YY : Year, M : Monthly, W : Weeks



**RAPIDTEK**  
**PHOTO DMOD RELAY**

Rapidtek Magnetic Devices Inc.  
<http://www.rapidtek.net>