

Miniature SOP-8pin type
of 350V load voltage

PHOTO DMOS RELAY AW35S

2 From A

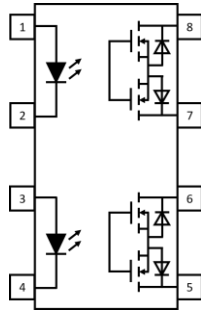
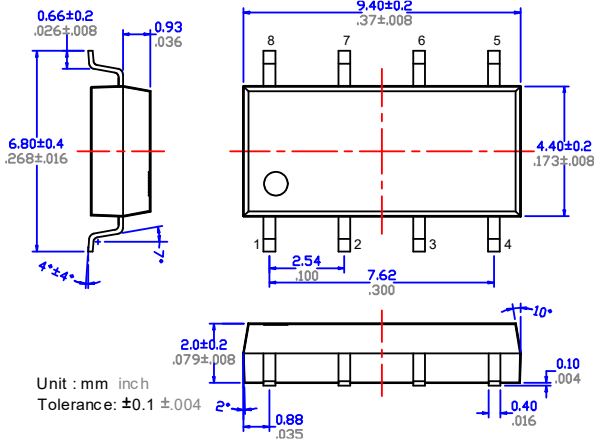

- 1,3. LED Anode
- 2,4. LED Cathode
- 5,6,7,8. MOSFET Drain

FEATURE

1. Continuous load current: Max. 120mA.
2. Load on resistance: Typ. 17Ω.
3. Loading voltage 350V DC or AC peak.
4. Off-state leakage current: 1μA.

TYPICAL APPLICATIONS

- Measurement and test equipment
- Telecommunications
- Security equipment
- Industrial machinery and equipment

Absolute maximum ratings (Ambient temperature 25 °C)

Item		Symbol	Value	Units	Not
Input	Continuous LED current	I_F	50	mA	
	Peak LED current	I_{FP}	1000	mA	f=100Hz, DC 1%
	LED reverse voltage	V_R	5	V	
	Input power dissipation	P_{in}	75	mW	
Output	Load voltage	V_L	350	V	DC or AC peak
	Load current	I_L	120	mA	
	Peak load current	I_{peak}	600	mA	100ms(1 pulse)
	Output power dissipation	P_{out}	300	mW	
Total power dissipation		P_T	350	mW	
I/O isolation voltage		V_{iso}	1500	Vrms	RH 60, 1min
Operating temperature		T_{opr}	-40o +85	°C	
Storage temperature		T_{stg}	-40 to +100	°C	
Soldering temperature		T_{sol}	260	°C	10sec max.

Electrical specifications (Ambient temperature 25 °C)

Item		Symbol	Min.	Typ.	Max.	Units	Condition
Input	LED forward voltage	V_F		1.2	1.4	V	$I_F=10mA$
	Operating LED current	I_{Fon}		0.5	3.0	mA	
	Recover LED current	I_{Foff}	0.1	0.35		mA	
	Recover LED voltage	V_{Foff}	0.5			V	
Output	On resistance	R_{on}		17.0	24.0	Ω	$I_F=5mA, I_L=100mA$
	Off-state leakage current	I_{leak}			1.0	μA	$V_L=Rating$
	Output capacitance	C_{out}		41		pF	$V_L=0V, f=1MHz$
Transmission	Turn on time	T_{on}		0.23	0.5	ms	$I_F=5mA, I_L=100mA$
	Turn off time	T_{off}		0.05	0.2	ms	
Coupled	I/O isolation resistance	$R_{I/O}$	10^9			Ω	DC 500V
	I/O capacitance	$C_{I/O}$		0.8	1.5	pF	f=1MHz



RAPIDTEK PHOTO DMOD RELAY

Rapidtek Magnetic Devices Inc.
<http://www.rapidtek.net>

PHOTO DMOS RELAY

2 Form A Photo Relay

Reference data

Load current vs. Ambient temperature

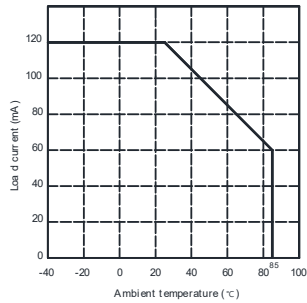

On resistance vs. Ambient temperature

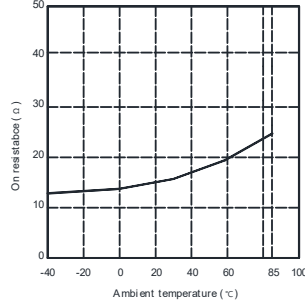

Turn on time vs. Ambient temperature

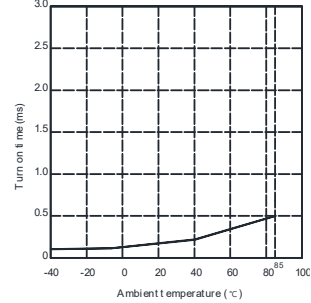

Turn off time vs. Ambient temperature

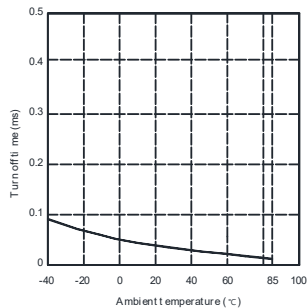

LED operate current vs. Ambient temperature

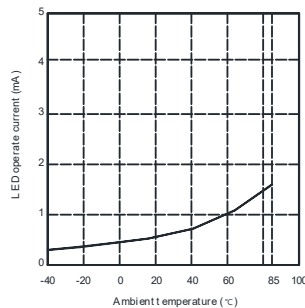

LED turn off current vs. Ambient temperature

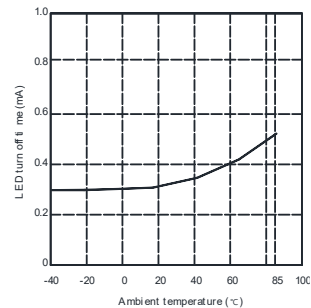

LED forward voltage vs. Ambient temperature

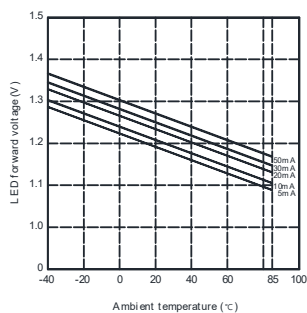

Voltage vs. current characteristics of output at

MOS portion

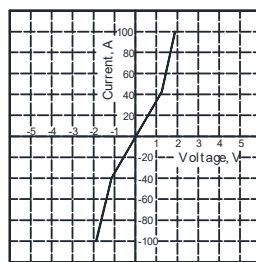

Off state leakage current vs. Load voltage

characteristics

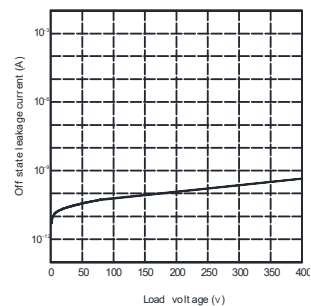

LED forward current vs. Turn on time

characteristics

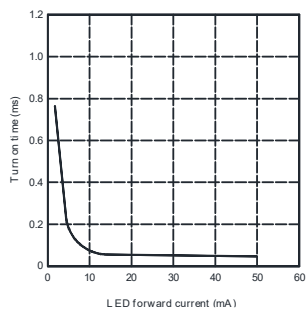

LED forward current vs. Turn off time

characteristics

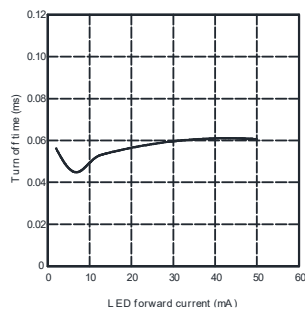

Applied voltage vs. Output capacitance

characteristics

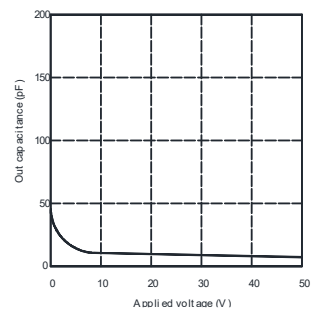

RAPIDTEK
PHOTO DMOD RELAY

Rapidtek Magnetic Devices Inc.
<http://www.rapidtek.net>

